

Capacité en chariots suivant modèles

UMX 1 TS7-2

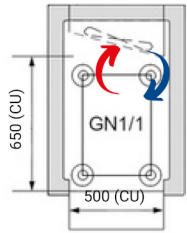

MX 1 TS7-2

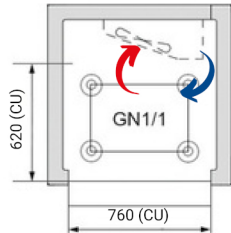

MX 1 L TS7-2

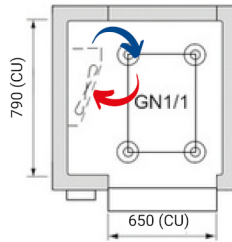

MX 2 TS7-2

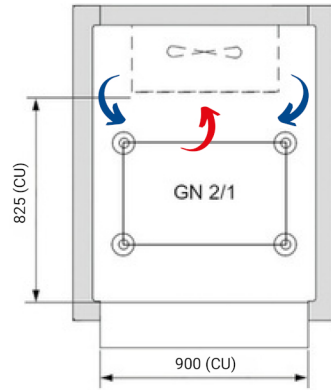

MX 27 TS7-2

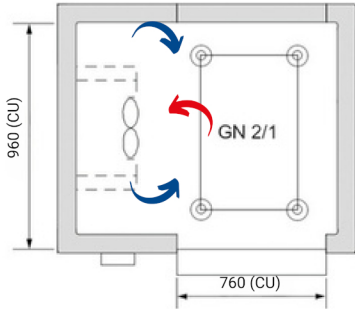

MX 29-2 TS7-2

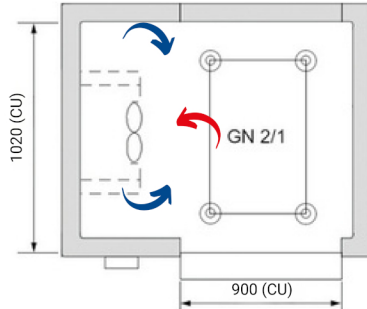

MX 3 TS7-2

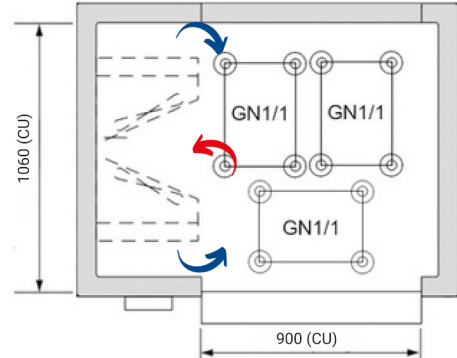

MX 4 TS7-2

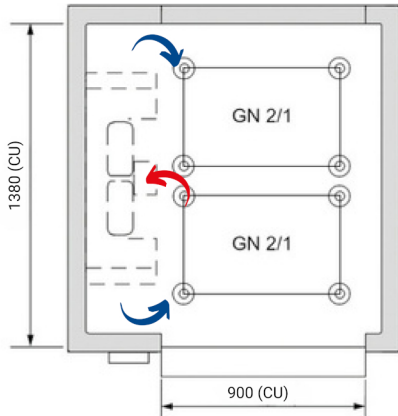

MX 6 TS7-2

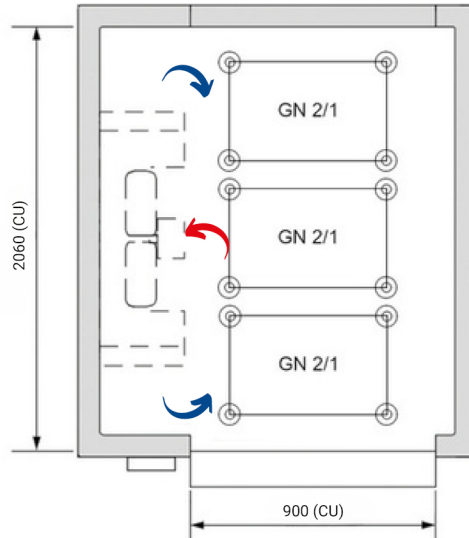

MX 29 SX TWIN TS7-2

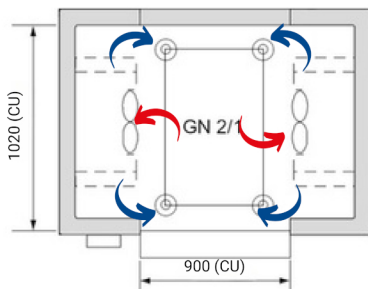

MX 4 SX TWIN TS7-2

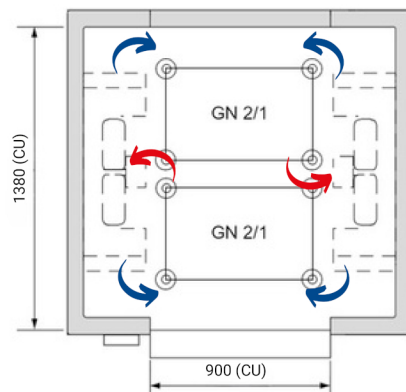

MX 6 SX TWIN TS7-2

